



PlayStation

®

NTSC U/C

®

PlayStation

EVERYONE

TM

E

CONTENT RATED BY  
ESRB

SLUS-00709  
04-17086

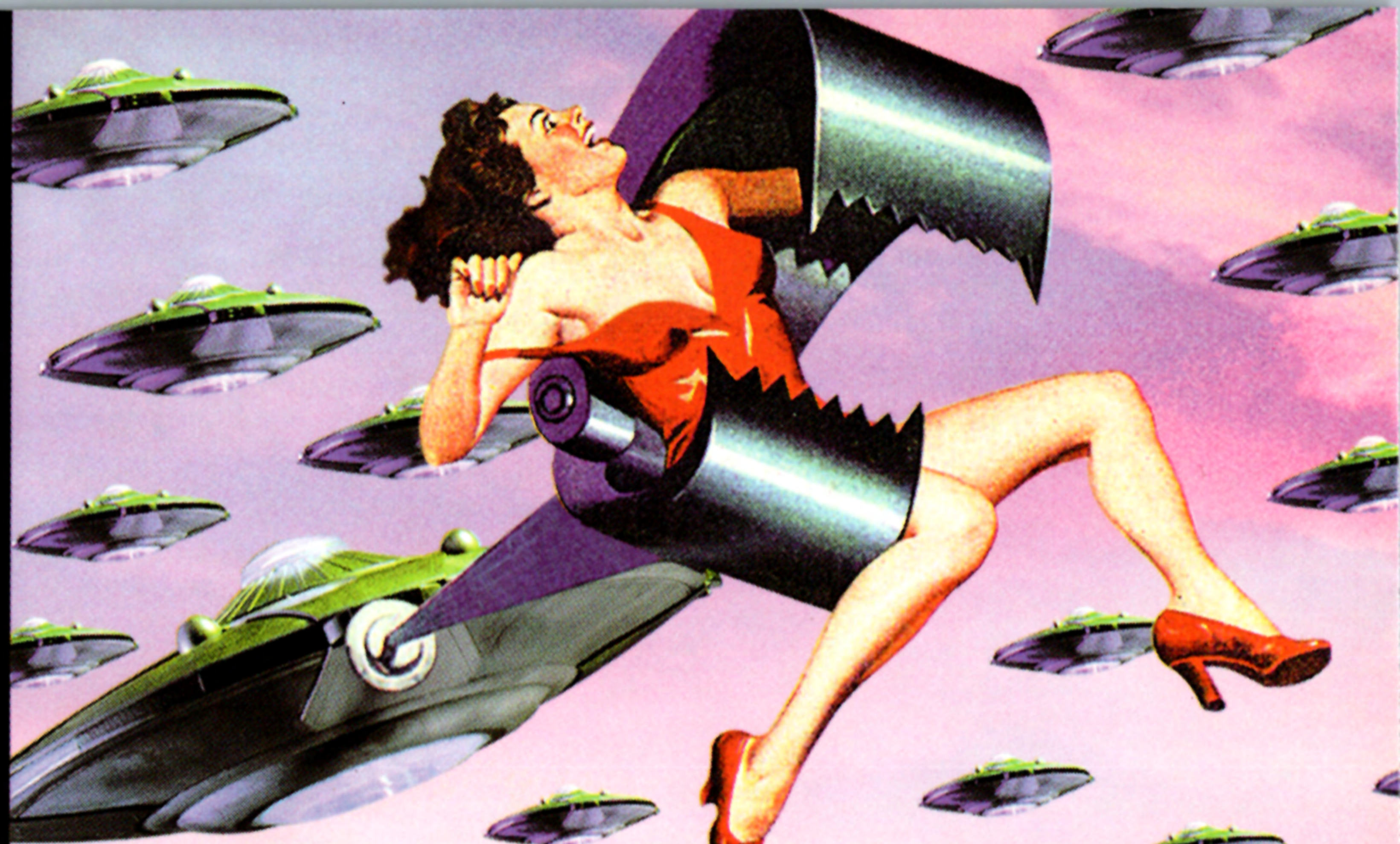

# INVASION FROM BEYOND™



GT Interactive  
Software  
[www.gtgames.com](http://www.gtgames.com)

# **WARNING: READ BEFORE USING YOUR PLAYSTATION® GAME CONSOLE**

***A very small percentage of individuals may experience epileptic seizures when exposed to certain light patterns or flashing lights. Exposure to certain patterns or backgrounds on a television screen or while playing video games, including games played on the PlayStation® game console, may induce an epileptic seizure in these individuals. Certain conditions may induce previously undetected epileptic symptoms even in persons who have no history of prior seizures or epilepsy. If you, or anyone in your family, has an epileptic condition, consult your physician prior to playing. If you experience any of the following symptoms while playing a video game—dizziness, altered vision, eye or muscle twitches, loss of awareness, disorientation, any involuntary movement, or convulsions—IMMEDIATELY discontinue use and consult your physician before resuming play.***

## **WARNING TO OWNERS OF PROJECTION TELEVISIONS:**

***Do not connect your PlayStation® game console to a projection TV without first consulting the user manual for your projection TV, unless it is of the LCD type. Otherwise, it may permanently damage your TV screen.***

## **HANDLING YOUR PLAYSTATION® DISC**

- This compact disc is intended for use with the PlayStation® game console.***
- Do not bend it, crush it or submerge it in liquids.***
- Do not leave it in direct sunlight or near a radiator or other source of heat.***
- Be sure to take an occasional rest break during extended play.***
- Keep this compact disc clean. Always hold the disc by the edges and keep it in its protective case when not in use. Clean the disc with a lint-free, soft, dry cloth, wiping in straight lines from center to outer edge. Never use solvents or abrasive cleaners.***

# TABLE OF CONTENTS

<b>START UP INFORMATION</b> .....	<b>2</b>
<b>MAIN MENU</b> .....	<b>2</b>
<b>MESSAGE FROM EARTHLINK</b> .....	<b>4</b>
<b>IN-GAME</b> .....	<b>5</b>
<b>THE SHIP HANGAR</b> .....	<b>6</b>
<b>INITIAL SHIPS AND THEIR PILOTS</b> .....	<b>9</b>
<b>MISSION BRIEF</b> .....	<b>11</b>
<b>CREDITS</b> .....	<b>16</b>
<b>TECHNICAL SUPPORT</b> .....	<b>18</b>



# START-UP INFORMATION

**Set up your PlayStation® game console according to its instructions. Insert *Invasion From Beyond* disc and close the Disc Cover. Insert game controllers and turn on the PlayStation® game console. Follow on-screen instructions to begin the game.**

## MAIN MENU

### **START NEW GAME**

**This will take you to the ship hangar where your missions will start.**

### **LOAD GAME**

**Load a previously saved game of *Invasion From Beyond*.**

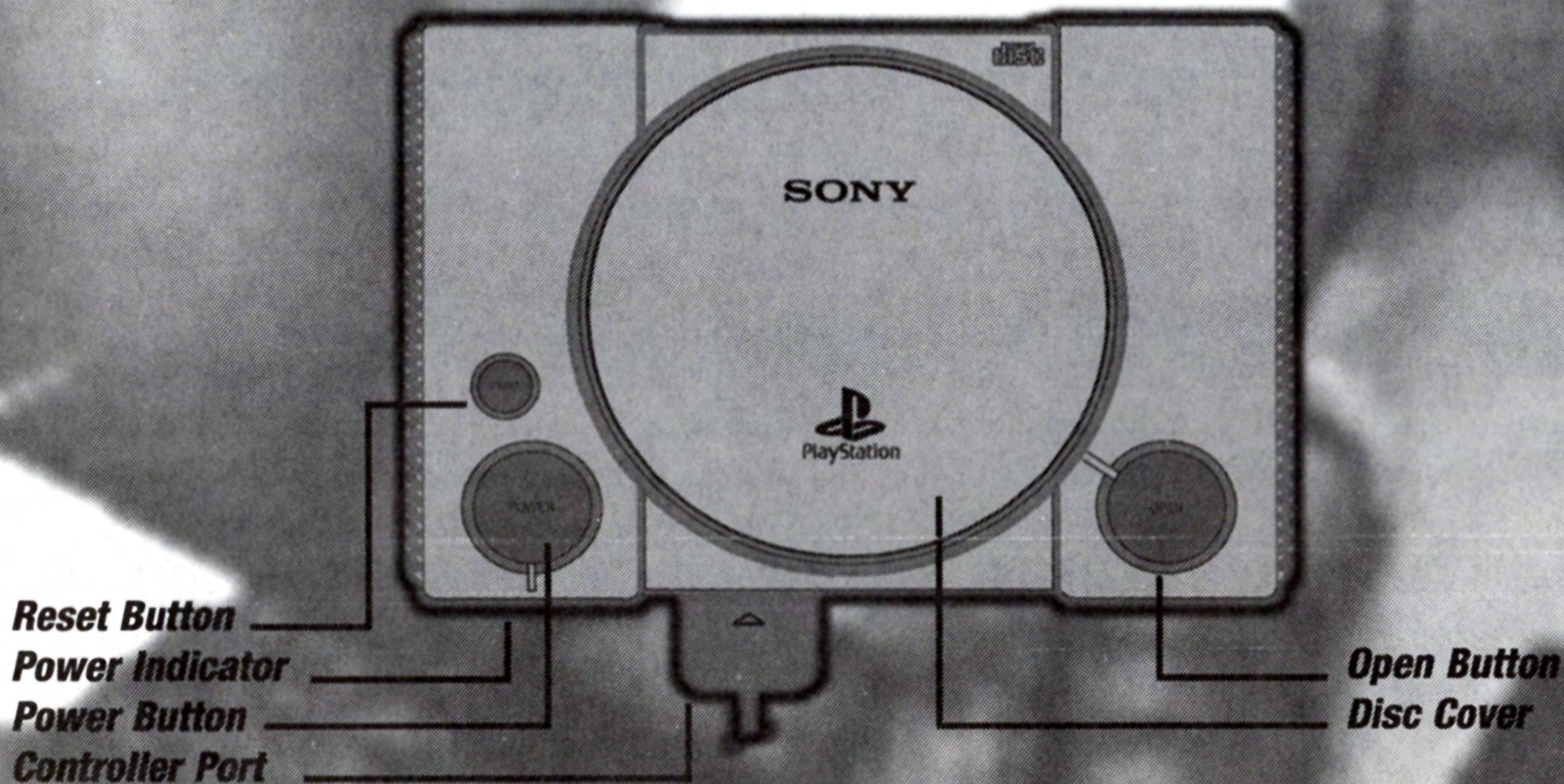

### FRONT VIEW

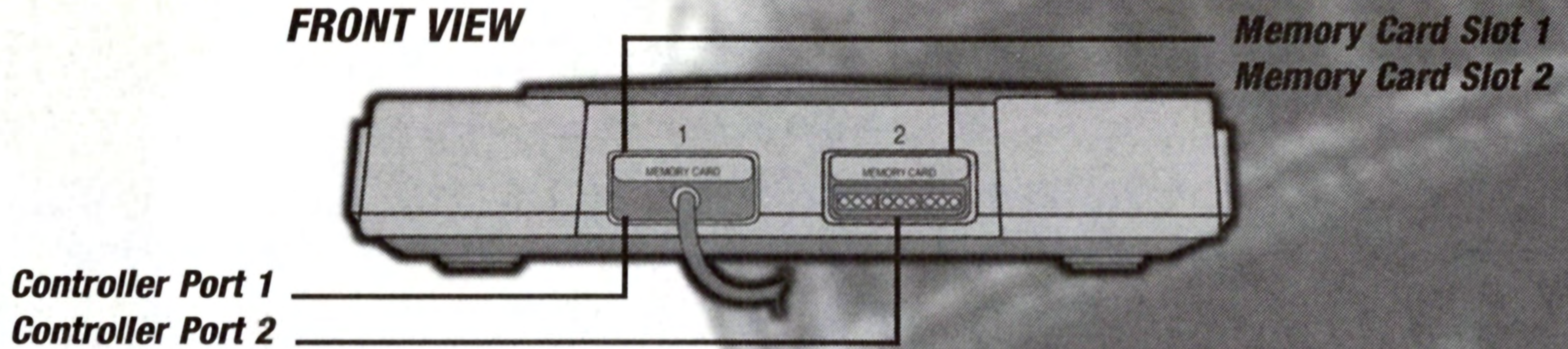

### FRONT VIEW

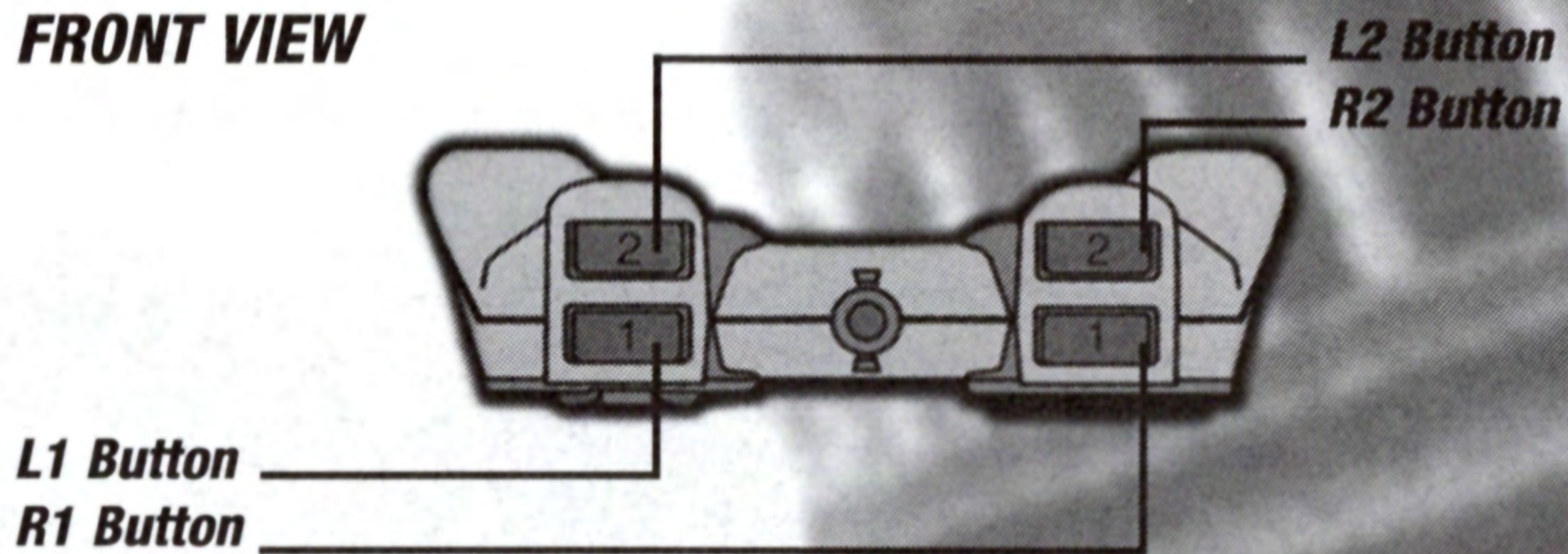

### TOP VIEW

Dual Shock™  
Analog Controller

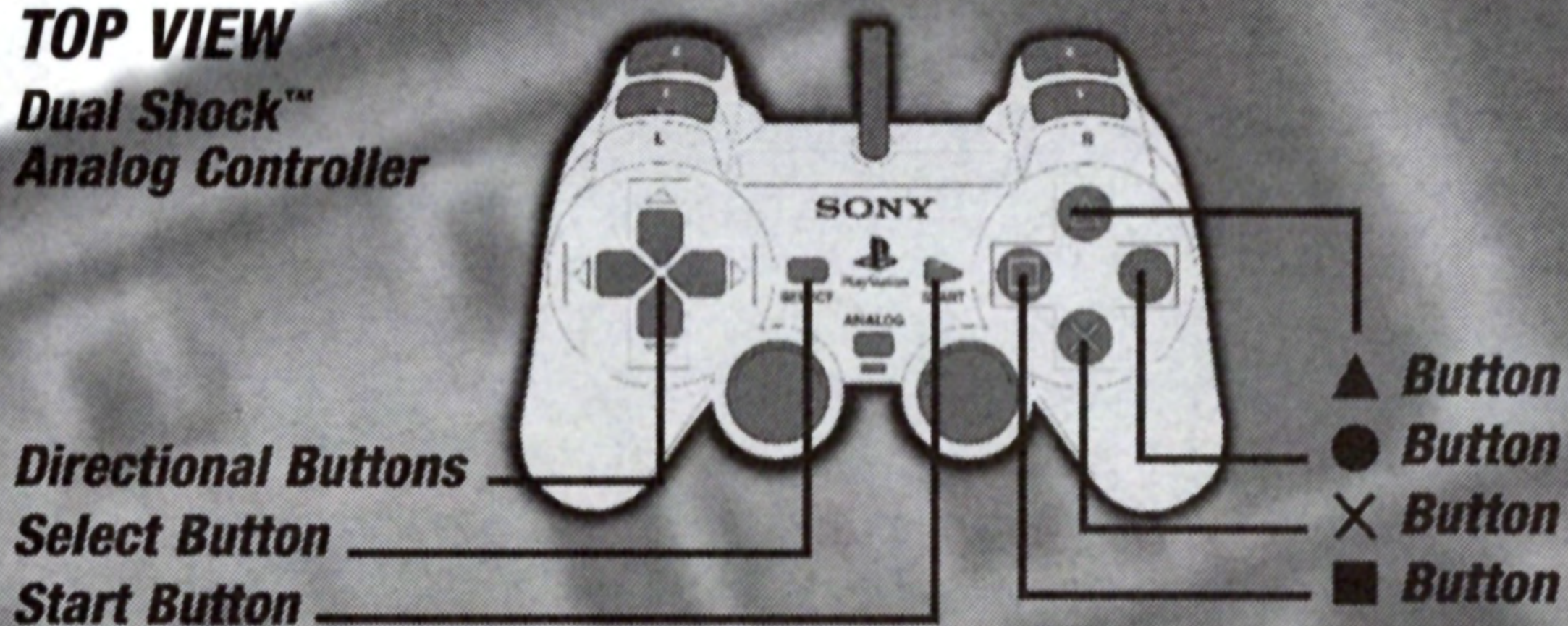

#### NOTE:

You may have a controller that looks like this. If so, please follow the digital instructions outlined above.

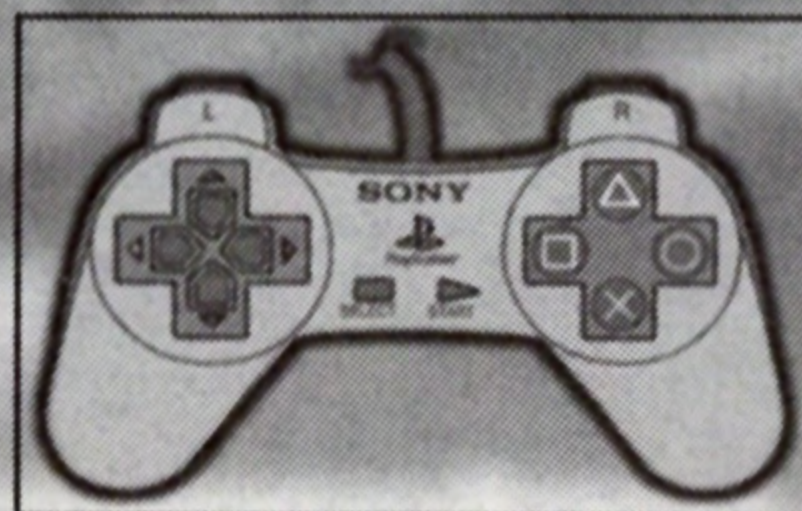

# **MESSAGE FROM EARTHLINK COMMAND**

***Our worst fears have been confirmed. The reported abduction of farm workers and the resulting discovery of crop circles in the farmlands outside Washington, D.C. were no coincidence. It seems that what started as an innocent country celebration, "Slap an Alien"—the locals' annual exorcism of superstitious fears—quickly became an unwitting welcome party for our Martian friends.***

***In the skies above TinyTown, hundreds of silhouettes are being reported on an almost hourly basis. The Eastern United States has experienced two full solar eclipses, in the last two days. Something extra-terrestrial is afoot! We have moved to DefCon1!***

***As a fully qualified Earthlink, pilot you must take on the Alien Invasion. With the aid of America's finest scientific brains and the unrivalled Earthlink research and development labs, you will follow the direct orders of the internationally acclaimed defense force. During your mission, you will pilot the latest developments in aircraft technology research and build new ships and weapon types for use in later encounters.***

***Manipulate the awesome ground-based firepower of Earthlink Command, prevent the Martian takeover and help us take the fight back.***

**WATCH THE SKIES, PILOT—AND GOOD LUCK!**

## **CONTROLS**

### **FRONT VIEW**

- L1** *Switch between suck / blow mode and cycle through cargo inventory*
- L2** *Strafe Left*
- R1** *Cycle through weapon slots to select desired weapon.*
- R2** *Strafe Right*

### **TOP VIEW**

- ▲** *Reverse*
- *Fire*
- X** *Accelerate*
- *Engage Suck-O-Matic*

*The above key configurations can be changed in the controller configuration screen, which can be found in the options menu, accessible from the ship hangar menu.*

### **SELECT**

*Display in-game mission briefs.*

*Hitting select while over the base displays your current mission plus a detailed description of your current base contents, including components and scientists rescued as well as the ships stored in your base hangar.*

### **START**

*Pause and Un-Pause the game.*

# **THE SHIP HANGAR**

## **HANGAR MENU**

### **ENTER MISSION**

*Begin the mission.*

### **SAVE GAME**

*Save your game progress. Invasion From Beyond takes one memory card slot per save.*

### **OPTIONS**

#### **SOUND/MUSIC VOLUME**

*Alters sound and music volume levels.*

#### **CONTROLLER CONFIGURATION**

*Invasion From Beyond supports the Standard Controller and Dual Shock™ Analog Controller.*

*In this screen, you will be able to change the default control configurations to better suit your piloting preferences. You may also turn on/off the vibration function.*

### **ABORT GAME**

*Aborts your current game and returns to the Invasion From Beyond main menu. You will be prompted for confirmation.*

## **MAIN HANGAR SECTION**

*You can deploy three ships, one at a time, during each mission. At the start of the game you will only have three ships available for selection (these are listed below), but keep in mind, as you research and build new ships (to a maximum of 12) you will only ever be allowed to deploy three ships per mission.*

*Choose your aircraft wisely. Each has its own individual pilot, handling characteristics, cargo space and weapon slots. If you lose one of your chosen three during a mission, it will be unavailable until the next mission while it undergoes essential repairs.*



**The panel on the left of the hangar screen displays the current three ships selected for service in the next mission. To change any of these ships, move the green cursor so that it points at the craft you wish to replace. Move through the hangar from left to right until the new ship you want to take into active service is displayed in the main viewing window, and hit X. The new will replace the old.**

**As a visual reminder, the bay in which selected ships reside will also have open launch doors, flashing red sirens and activated green runway strip lights.**

## **RESEARCH AND DESIGN**

**To research, design and build new ships and weapon types, tap ● in the main hangar screen.**

**During missions, aside from your primary mission objectives and Earthlink guidelines, you must also collect alien components and rescue scientists and bring them all back to base as often as you can (Instructions on how to do this later). On completion of a mission, you return to your hangar where you can implement these salvaged items and professors to build your new arsenal.**

**Once you have built new ships and weapons, you can test them out in the Earthlink simulator. Select this option from the hangar menu. Fly your new aircraft and test your new weapons against dummy alien saucers in the Earthlink VR environment.**

**Components are used to build new ships and weapons. The relative costs of each are displayed in the R&D screens on selection.**

**They look like this:**



**Scientists rescued can be used to increase the firepower, power level and cooling rate of your existing weapons.**

**They look like this:**



## **WEAPONS**

**In the hangar you will initially be given two weapons, they are:**



### **MACHINE GUN**

**Auto-targeting chain gun. Spits rapid lead at the aliens.**



### **PUMMEL ROCKET**

**Unguided rocket. Takes out smaller UFOs with one shot but you have to be accurate.**

**There are over 12 more weapons for you to build as the game progresses. This all depends on the number of components you collect during missions. If you're a conscientious pilot, you should build about one weapon per level. Once you have built a weapon you can allocate it to any one of your ships. Because some weapons are more powerful than others, some have a maximum number you can attach to any one ship. However, you are not limited to the number of your ships you can attach them to.**

## **EQUIP SHIP**

**You will need to monitor your fleet's power and technology upgrades regularly. Once you have built and researched new weapons, you're going to want to clamp them on to your alien-stomping airforce, your new and old ships.**

*Highlight the ship you want to equip by moving it into the main viewing window of the hangar. Hit ●. The camera will switch to an overhead position and automatically reveal the weapon slots available for that craft. The weapons currently available for selection are displayed in a window above the ship.*

*Simply highlight the desired weapon and tap X, move the flashing cursor to the required weapon slot (vacant or used, it does not matter) and hit X again. You can use this method to load new weapons or replace previous selections. Old revisions of the same weapon will automatically be upgraded with the new.*

*Weapon information is listed in the descriptive window to the right of the ship. This gives details of the weapon type, effect and power. This will also relay information concerning any minimum and maximum numbers of the selected weapon allowed on the same ship at any one time.*

*Hit ▲ to return to the hangar main view.*

*If you make modifications to any of your ships, you will be prompted by Earthlink command as to whether or not you want to select this ship for active service.*

*Don't forget the ships you have currently selected for combat can be seen in the window on the left of the hangar screen.*

## **INITIAL SHIPS AND THEIR PILOTS**

*Viewing from left to right in the hangar area, the first three ships are:*

### **SILVERFISH**



#### **SHIP DATA:**

*The first candidate in the UN fleet for front-line duty against the Alien invasion. A highly maneuverable and durable aircraft. Perfect for the newly qualified pilot.*

**Cargo Hold: 5**  
**Weapon Pods: 5**

**PILOT:**



**Name:** Irwin Stryker  
**Age:** 28  
**Birthplace:** Denver, Colorado  
**Biography:** After a brief but unsuccessful career in vacuum sales Irwin moved on to the US Air Force. He achieved the ultimate honor, the Purple Helmet, for successfully stealing a secret aircraft from the Russians—the Silverfishski.



**RED DEVIL**

**SHIP DATA:**

A fast and responsive aircraft, the Red Devil is the ideal fighter for close-range UFO destruction. Tight turns and good acceleration, perfect for when a pilot really needs to get in, do the job and get you out in one piece.

**Cargo Hold: 6**  
**Weapon Pods: 3**

**PILOT:**



**Name:** Dominique Dallas  
**Age:** 18  
**Birthplace:** Houston, Texas  
**Biography:** After an unsuccessful career in Hollywood, spent mostly on the tinsel town casting couches, Dominique applied for Earthlink pilot status and found her true vocation—she passed first time.

## WHIPLASH MK.II



### SHIP DATA:

*The name for the ship comes from the test pilots' most frequent injury. Pilot this ship for only a matter of seconds and you'll understand. It's low on cargo space and weapon slots but the Whiplash more than makes up for these weaknesses with sheer speed and maneuverability.*

**Cargo Hold: 4**

**Weapon Pods: 4**

### PILOT:



**Name:** Clark Cable

**Age:** 41

**Birthplace:** Plumstead, England

**Biography:** *Piloting the breakneck Whiplash Mk.II is no mean feat. Clark is the perfect man for the job. After suffering a life-threatening crash in a Go-Karting event, Clark's spine has been reinforced with a solid titanium core. Perfect for the 0 to 200 mph and back to 0 in 3 seconds performance level of the new Whiplash model.*

**THERE ARE NINE NEW SHIPS FOR YOU TO BUILD AND DISCOVER.**

**Hit 'Start' to enter the mission. Select 'Start Mission' to begin.**

## MISSION BRIEF

**Your prime directive is to annihilate all invading alien forces. But whenever Earthlink command requires specific objectives and sub-missions completed, you will be notified via a flashing communications icon and a sonic Morse code warning. Hit select and your current mission brief will be displayed.**

**You can also scroll back to older briefings to monitor your progress. If you are in the thick of battle when the icon appears don't worry, if you have any**

*unread messages the icon will stay on-screen until it is read.*

*Important: All current primary objectives are marked in white on your radar and indicated using a green arrow in the level.*

## **YOUR SHIP**

*The ship you are currently piloting is in the center of the screen (but you already knew this, right?). All the ships in the Earthlink fleet move and operate in much the same way, but all have their own quirks and characteristics. All ships accelerate forward, decelerate and reverse, strafe to the left and right and tip their nosecones up or down to aid you with targeting.*

*You will also find your ship closely hugs the landscape and all its undulating surfaces. This auto altitude tracking means you can concentrate on pointing your weapons at the Invaders, rather than piloting your ship. The plasma trail behind your ship also indicates its overall condition. If the trail turns black and begins to billow smoke you're in trouble and need to get back to base for a much needed re-charge.*

## **RADAR**

*The radar in the bottom left of the screen displays your current position in the game world. Your ship is dead center. The angles pointing forward represent your field of vision.*

*Other Sonar blips on the radar are:*

<b>RED</b>	<b>Aliens</b>
<b>ORANGE</b>	<b>Alien ground troops</b>
<b>DARK BLUE</b>	<b>AAA guns</b>
<b>YELLOW</b>	<b>Your base</b>
<b>WHITE</b>	<b>Current mission objective</b>
<b>PURPLE</b>	<b>Human civilians</b>
<b>LIGHT BLUE</b>	<b>Ground vehicles (Human)</b>
<b>LARGE LIGHT BLUE</b>	<b>Aircraft (Human)</b>

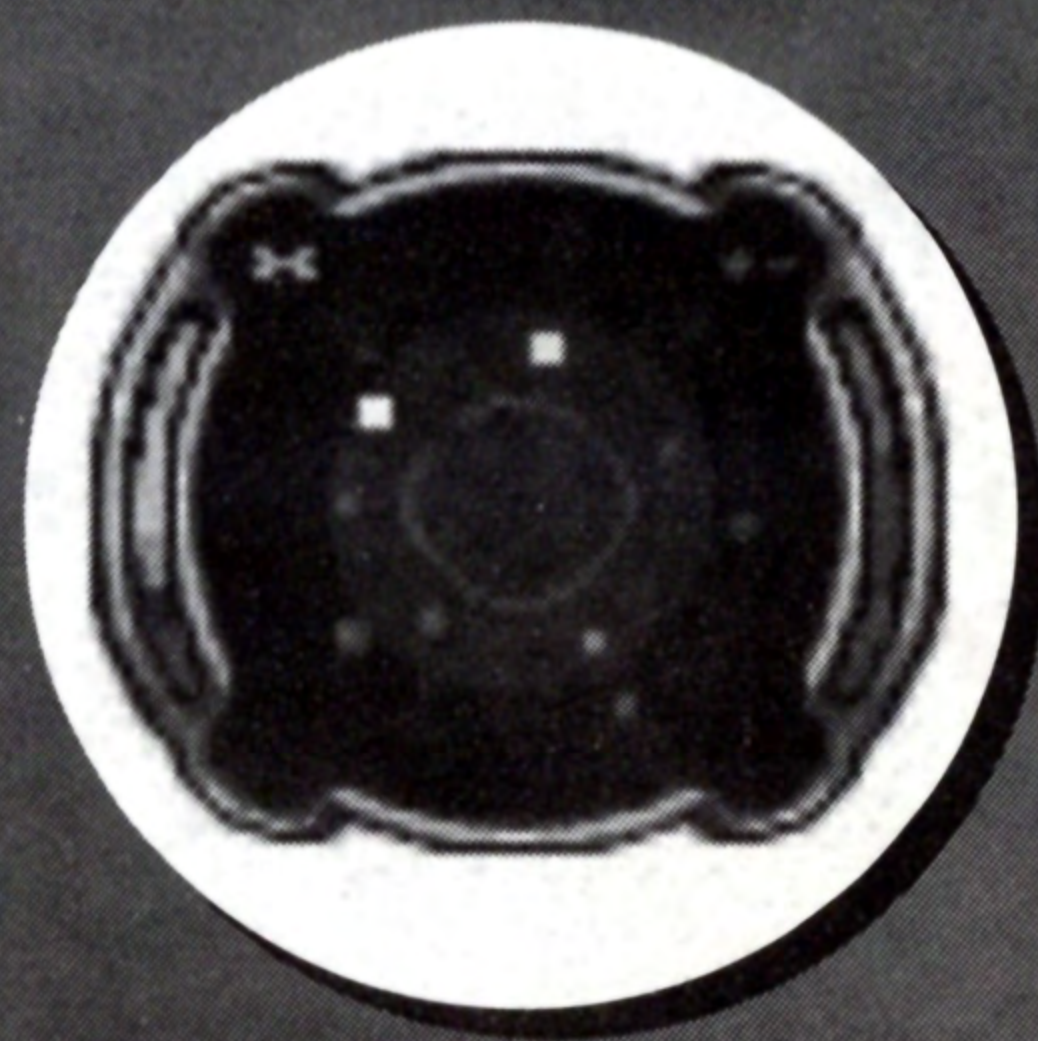

*On the left is your ship's damage bar. On the right is your Ship's energy bar.*

## **CARGO HOLD**

*This indicates the number of slots available in your cargo hold for collecting people and items from the landscape. The number of slots varies from ship to ship. Once you collect an object or person, an icon will be displayed relevant to the object gathered.*

*A green arrow points up towards your next vacant cargo slot. Hitting L1 switches the arrow to red and points it down. This indicates the object selected for ejection from your cargo.*

## **WEAPON MOUNTS**

*Shows the number of weapon slots available for the current ship and which weapon you are currently using.*

## **AIMING RETICULE**

*The reticule moves in front of your ship and operates in a different way depending on your current weapon selection. The more powerful weapons and most projectile weapons have manual targeting systems. Weapons like the chain-gun, laser weapons and guided missiles lock on to your selected target automatically. Essential for tracking fast moving targets.*

*The aiming reticule also indicates the location of your Suck-o-Matic teleport column. To suck up objects and people from the landscape, place the target over your intended cargo and hit ● to start the vacuum. Switching the Suck-o-Matic to blow places your intended ejection item in the location indicated by your target. A small icon will be a further guide as to what item you are about to eject.*

## **SUCK-O-MATIC**

*An experimental device attached to all ships by default. You will use the Suck-o-Matic a lot during the game. This teleport device sucks and blows items in and out of your ships cargo hold. Keep in mind that if you swap ship's during a mission while over your base the ship's contents will remain in the ship while it is repaired.*

*The Suck-o-Matic is absolutely essential for collecting alien technology, rescuing scientists, picking up civilians, relocating AAA Guns and other objects, and capturing aliens for research.*

## **YOUR BASE**

*When your ship takes too much damage and / or your weapons and shield energy is depleted, an alarm will sound. When this happens, return to your base as soon as possible, where your ship's energy will be recharged. At the same time, any components, scientists and aliens collected since your last visit will be automatically deposited in your base storage.*

*If one of your ships becomes heavily damaged, you can return to your base and switch to a different ship. After a few minutes in the base, the damaged ship will be as good as new.*

## **COMPONENTS**

*When certain alien saucers are destroyed, extra-terrestrial components fall from the debris. These pieces can be salvaged by sucking them into your cargo hold and depositing them back at base. You can use these components later in your ship's hangar to build new ships and weapons.*

*Components look like this:*



## **SCIENTISTS**



*All Earth scientists have been instructed by the US Government to help their country in the technological fight against the Alien Invaders. However, as the Alien Bombers destroy our buildings many of the Universities and labs used by the scientists are destroyed. This*

*leaves them wandering the landscape desperately trying to avoid the invading force's attention.*

*Rescuing these scientists using your Suck-o-Matic is of enormous advantage to your battle against the Martians. Once you rescue rogue scientists, take them back to your base where they will be safely deposited. In your post-mission hangar screens you can allocate these scientists to improving the technology of your current weapon selection. This affects your weapons' accuracy, firepower, cooling and fire rate.*



## **ALIENS**



*Earthlink is aware of at least 20 different types of alien saucers and attack aircraft spotted on radar. All will undoubtedly have different attack methods, movement strategies and objectives. Fighters, Bombers, Abductors and Landers are just a few you will encounter.*

*Besides the Aircraft and Saucers from Mars you will also have to deal with Alien ground troops from time to time. These small, fat, green aliens will walk the landscape attacking buildings, killing civilians and attacking your base. Destroy them on sight! If there are enough of them on the ground you'll be surprised how much damage they can cause when they start firing at you.*

*Aliens can also be sucked up into your cargo and taken back to base. Here Earth scientists will begin various experiments and psychological profiles, the results of which you will no doubt discover later on in the campaign!*

*Don't keep them in your hold for too long though; they will eat any people in storage and then move on to your engine room with their wrenches and wreak havoc.*

## **AAA GUNS**



*In some areas AAA Guns are already in place. More will be delivered during your mission. These artificially intelligent automatic gun turrets fire at will when they sight any*

*inbound alien aircraft. But you can also move them to wherever they help you the most. Move them just like any object, by using your Suck-o-Matic. AAA Guns are especially effective when defending prime alien targets, such as your base and civilian safe houses.*

*In the first few missions you will have a few medium strength AAA Guns at your disposal. As the missions increase in difficulty and more alien craft are captured you will have as many as 14 new AAA Gun types for your defense purposes.*

*Here ends the pilot briefing. Give 'em all you got, pilot, and remember—if it's saucer shaped, floats and is annoying, take it down!*

**GOOD LUCK EARTHLINK PILOT!**

# CREDITS

## **KING OF THE JUNGLE**

### **PROGRAMMING:**

*Raffaele Cecco*

*Paul Margrave*

*Stephane Koenig*

### **LEAD ARTIST:**

*Jolyon Myers*

### **ARTIST:**

*Mark Bentley*

### **SOUND FX:**

*Joylon Myers*

### **PRODUCER:**

*Stephane Koenig*

### **DESIGN:**

*Raffaele Cecco*

*Joylon Myers*

*Mark Bentley*

*Stephane Koenig*

*Paul Margrave*

*Pete Hawley*

## **GT INTERACTIVE EUROPE**

### **DEVELOPMENT DIRECTOR:**

*Graeme Boxall*

### **PRODUCER:**

*Pete Hawley*

### **ASSISTANT PRODUCER:**

*Tim Mawson*

## **GT INTERACTIVE US**

### **VP OF MARKETING:**

*Holly Newman*

### **MARKETING MANAGER:**

*Chris Mollo*

### **DIRECTOR OF PRODUCT DEVELOPMENT SERVICES:**

*Mary Steer*

### **QA MANAGER:**

*Steve Cowser*

### **TEST LEAD:**

*Jim Dunn*

*Tim Hess*

*Joe Schultz*

### **TESTERS:**

*AJ Pardilla*

*Yume Gregersen*

*Josh Galloway*

*Patrick Struhs*

*Scott Donaldson*

*Keith Moran*

**CREATIVE SERVICES:**

**DIRECTOR OF CREATIVE SERVICES:**

*Leslie Mills*

**CREATIVE DIRECTOR:**

*Vic Merritt*

**PRODUCTION MANAGER:**

*Liz Fierro*

**GRAPHIC ARTIST:**

*Jill Pomper*

**MANUAL EDITOR:**

*Peter Witcher*

**DEATH STAR OPERATOR:**

*Christopher Ziliotto*

# **TECHNICAL SUPPORT**

## **U.S. & CANADA**

### **ASSISTANCE VIA WORLD WIDE WEB**

*Get up-to-the-minute technical information at the GT Interactive Software web-site, at: <http://www.gtisonline.com>, twenty-four hours a day, seven days a week. Through this site you'll have access to our FAQ documents, (Frequently Asked Questions) which contain our latest product information. You'll have access to our Hints/Cheat Codes area where you can pick up some tips if they're available, and an E-Mail area where you can leave us your tech support problems and questions if you do not find your answers within the FAQ.*

### **HELP VIA TELEPHONE/FAX OR MAIL**

*For phone assistance, call GT Interactive Software's Tech Support at 425-398-3074. We have an Interactive Voice Response and Faxback system that is available twenty-four hours a day, seven days a week. This automated support which will include information from our FAQ documents such as gameplay tips, information on Control Keys, possible cheat code combination keys, instructions for finding secret screens and/or additional game levels if these type items exist and are made available for this particular product. If you should need live support, we are available Monday through Friday, 7:30 AM until 7:30 PM (PST). Please note that live Tech Support may be closed on major holidays. You may also fax in your Technical Support questions or problems to: (425) 806-0480, or write in to the address below.*

### **PRODUCT RETURN PROCEDURES**

*If you encounter what may be determined to be a defective product medium issue such as your game freezing at the beginning or during gameplay, no display, etc., you must call our technicians at 425-398-3074. If they determine that you will need to forward materials directly to us, please include a brief letter explaining what is enclosed and why. Make sure you include the Return Merchandise Authorization Number (RMA#) supplied you by the technician and your telephone number in case we need to call you. Any materials not containing this RMA# will be returned to you unprocessed. Your mail should be sent to the following address:*

**GT Interactive Software  
13110 NE 177th Place  
Suite # B101, Box180**

**Woodinville, WA 98072-9965  
Attn: Technical Support  
RMA#: (include your RMA# here)**

## **WARRANTY POLICY**

**If our technicians determine that the product storage medium is found to be defective within ninety (90) days of original purchase, (unless otherwise provided by applicable law), GT Interactive Software will replace the item free of charge, to the original purchaser, if the item is accompanied by the original dated receipt and packaging. If you do not have the original receipt, or if the warranty period has expired, GT Interactive Software will replace the product storage medium for a nominal fee.**

**If your product information contains Technical Support phone numbers for Europe, you must contact those phone numbers and abide by their warranty policies.**

## **EUROPE**

### **HELP VIA TELEPHONE IN EUROPE**

**Technical Assistance:**

**English speaking customers call 01923 209145**

**Assistance Technique:**

**Remarque: Notre service de soutien technique se trouve en Angleterre. Clients francophones appelez le 00 44 1923 209148**

**Technischer Kundendienst:**

**Beachten Sie bitte dass sich unser technischer Kundendienst in England befindet. Den deutschsprachigen Kundendienst erreichen Sie unter folgender Nummer: 00 44 1923 209151**

## **OTHER**

**Please do not make unauthorized copies The program you've purchased was produced through the efforts of many people who earn their livelihood from its lawful use. Don't make copies for others who have not paid for the right to use it. To report copyright violations to the Software Publishers Association, call 1-800-388-PIR8 or write:**

**Software Publishers Association  
1101 Connecticut Ave., Suite 901  
NW Washington, DC 20036**

**This program is protected by United States federal and international copyright laws. All trademarks mentioned in this manual are the property of their respective owners.**

# NOTES

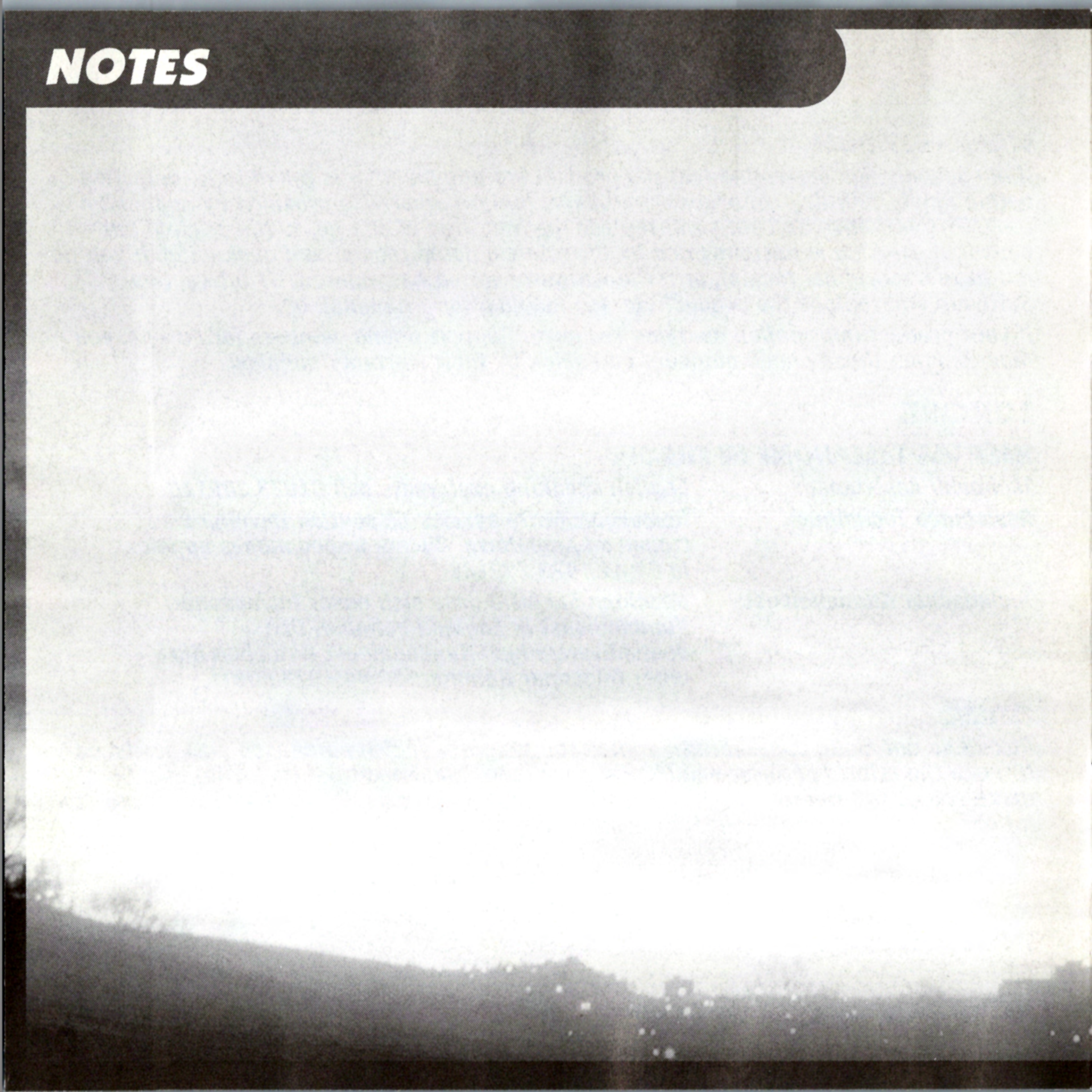

## END-USER LICENSE AGREEMENT

PLEASE READ CAREFULLY. BY USING OR INSTALLING THIS SOFTWARE, OR BY PLACING OR COPYING THIS SOFTWARE ON YOUR COMPUTER HARDWARE, COMPUTER RAM OR OTHER STORAGE MEDIUM, YOU ARE AGREEING TO BE BOUND BY THE TERMS OF THIS LICENSE. IF YOU DO NOT AGREE TO THESE TERMS, PROMPTLY RETURN THE PRODUCT IN ITS PACKAGING TO THE PLACE WHERE YOU OBTAINED IT.

1. License. The software accompanying this license (the "Software") and the related documentation are licensed to you by us and are subject to this license. If the Software is configured for loading onto a hard drive, you may so load the Software only onto the hard drive of a single computer and run the Software off only that hard drive. You may not delete the copyright notices or any other proprietary legends on the original copy of the Software. If there is an editor incorporated into the Software, this license is also subject to Section 8 below. You agree that the Software will not be shipped, transferred or exported into any country in violation of the U.S. Export Administration Act (or any other law governing such matters) by you or anyone at your direction and that you will not utilize and will not authorize anyone to utilize, in any other manner, the Software in violation of any applicable law. The Software may not be downloaded or otherwise exported or reexported into (or to a national or resident of) any country to which the U.S. has embargoed goods or to anyone or into any country who/which are prohibited by applicable law, from receiving such property.
2. Restrictions. The Software contains copyrighted material, trade secrets and other proprietary material. You may not decompile, modify reverse engineer, publicly display, prepare derivative works based on the Software (except as permitted in Section 8, below), disassemble or otherwise reproduce the Software. You may not rent, sell, lease, sublicense or distribute the Software. You may not offer the Software on a pay-per-play basis or otherwise commercially exploit the Software or use the Software for any commercial purpose. You may not electronically transmit the Software from one computer to another or over a network.
3. Termination. This license is effective until terminated. You may terminate this license at any time by destroying the Software and related documentation. This license will terminate immediately without notice from us if you fail to comply with any provision of this license. Upon termination, you must destroy the Software and related documentation.
4. Disclaimer of Warranty on Software. You are aware and agree that use of the Software and the media on which it is recorded is at your sole risk. The Software, related documentation and the media are provided "AS IS". Unless otherwise provided by applicable law, GT Interactive Software Corp. ("GT") warrants to the original purchaser of this product that the Software storage medium will be free from defects in material and workmanship under normal use for ninety (90) days from the date of purchase. This warranty is void if the defect has arisen through accident, abuse, neglect or misapplication. GT EXPRESSLY DISCLAIMS ALL OTHER WARRANTIES, EXPRESS OR IMPLIED, INCLUDING BUT NOT LIMITED TO, THE IMPLIED WARRANTIES OF MERCHANTABILITY AND FITNESS FOR A PARTICULAR PURPOSE. WE DO NOT WARRANT THAT THE FUNCTIONS CONTAINED IN THE SOFTWARE WILL MEET YOUR REQUIREMENTS, NO ORAL OR WRITTEN INFORMATION OR ADVICE GIVEN BY US OR ANY OF OUR AUTHORIZED REPRESENTATIVES SHALL CREATE A WARRANTY OR IN ANY WAY INCREASE THE SCOPE OF THIS WARRANTY. SOME JURISDICTIONS DO NOT ALLOW THE EXCLUSION OF IMPLIED WARRANTIES, SO THE ABOVE EXCLUSIONS MAY NOT APPLY TO YOU.
5. Limitation of Liability. UNDER NO CIRCUMSTANCES, INCLUDING NEGLIGENCE, SHALL GT OR ITS OFFICERS, EMPLOYEES, DIRECTORS, AGENTS, LICENSEES, SUBLICENSEE OR ASSIGNS BE LIABLE FOR ANY INCIDENTAL, SPECIAL OR CONSEQUENTIAL DAMAGES THAT RESULT FROM THE USE OR INABILITY TO USE THE SOFTWARE OR RELATED DOCUMENTATION, EVEN IF SUCH PARTIES HAVE BEEN ADVISED OF THE POSSIBILITY OF THOSE DAMAGES. SOME JURISDICTIONS DO NOT ALLOW THE LIMITATION OR EXCLUSION OF LIABILITY FOR INCIDENTAL OR CONSEQUENTIAL DAMAGES SO THE ABOVE LIMITATION OR EXCLUSION MAY NOT APPLY TO YOU. In no event shall our total liability to you for all damages, losses, and causes of action (whether in contract, tort or otherwise) exceed the amount paid by you for the Software.
6. Controlling Law and Severability. This license shall be governed by and construed in accordance with the laws of the State of New York, USA. Exclusive venue for all litigation shall be in New York, New York. If any provision of this license is unenforceable, the rest of it shall remain in effect.
7. Complete Agreement. This license constitutes the entire agreement between the parties with respect to the use of the Software and the related documentation.
8. Editor and End-user Variations.
  - (a) The Software may include an "Editor". An "Editor" is a feature which allows you to modify the Software or to construct new variations for use with it. These modifications and variations can be both playable and non-playable. An Editor includes its associated tools and utilities. An Editor is NOT shareware. You may not freely distribute it to any BBS, CD, floppy or any other media. You may not sell it or repackage it for sale.
  - (b) Using the Editor, you may create modifications or enhancements to the Software, including the construction of new levels (collectively referred to as "Variations"), subject to the following restrictions:
    - i. Your Variations must only work with the full, registered copy of the Software, not independently or with any other software.
    - ii. Your Variations must not contain modifications to any executable file.
    - iii. Your Variations must not contain any libelous, defamatory, or other illegal material, material that is scandalous or invades the rights of privacy or publicity of any third party, or contains any trademarks, copyright-protected work, or other recognizable property of third parties.
    - iv. At least once in every online description and with reasonable duration on the opening screen, your Variations must prominently identify (i) the names and email addresses of its creators, and (ii) the words "THIS LEVEL IS NOT MADE BY OR SUPPORTED BY GT Interactive Software Corp., The WizardWorks Group, Inc., or any of such parties affiliates and subsidiaries."
    - v. Your Variations must be distributed solely for free. Neither you nor any other person or party may sell them to anyone, commercially exploit them in any way, or charge anyone for using them. You may exchange them at no charge among other end-users.
    - vi. By distributing or permitting the distribution of any of your Variations, you hereby grant back to GT an irrevocable, worldwide, royalty-free right to use and distribute them by any means.
    - vii. The prohibitions and restrictions in this section apply to anyone in possession of the Software or any of your Variations.
9. Copyright. The Software and all copyrights, trademarks and all other conceivable intellectual property rights related to the Software are owned by GT or its licensors and are protected by United States copyrights laws, international treaty provisions and all applicable law, such as the Lanham Act. You must treat the Software like any other copyrighted material, as required by 17 U.S.C. section 101 et seq. and other applicable law. You agree that you are receiving a copy of the Software by license only and not by sale and that the "first sale" doctrine of 17 U.S.C. section 109 does not apply to your receipt or use of the Software.

Please do not make unauthorized copies. The program you've purchase was produced through the efforts of many people who earn their livelihood from its lawful use. Don't make copies for other who have not paid for the right to use it. To report copyright violations to the Software Publishers Association, call 1-800-388-PIR8 or write:

Software Publishers Association, 1101 Connecticut Ave., Suite 901, NW Washington, DC 20036

This program is protected by United States federal and international copyright laws.

All trademarks mentioned in this manual are the property of their respective owners.

YOU MAY NOT DISTRIBUTE THIS VERSION OF THE SOFTWARE.

Need a hint?

1-900-CALL-2GT

1-900-225-5248

(95¢ per minute. \$1.95 for fax back maps.)

must be 18 years or older, or have parent's permission  
to call. touch tone phones only.

[www.gtgames.com](http://www.gtgames.com)

 **GT Interactive  
Software**  
[www.interactive.com](http://www.interactive.com)

Invasion From Beyond ©1998 GT Interactive Software Corp. All Rights Reserved. Created by King of the Jungle Limited. Published and distributed by GT Interactive Software Corp. Invasion From Beyond uses Quick3D technology. Copyright ©1997 King of the Jungle Limited. GT and the GT Games Logo are trademarks and the GT Logo is a registered trademark of GT Interactive Software Corp. All other trademarks are the property of their respective companies.

Licensed by Sony Computer Entertainment America for use with the PlayStation game console. PlayStation and the PlayStation logos are registered trademarks of Sony Computer Entertainment Inc. The ratings icon is a trademark of the Interactive Digital Software Association. Manufactured and printed in the U.S.A. THIS SOFTWARE IS COMPATIBLE WITH PLAYSTATION GAME CONSOLES WITH THE NTSC U/C DESIGNATION. U.S. AND FOREIGN PATENTS PENDING.

